

Žični termostat / Žični termostat / Wired thermostat

 **SASWELL SAS908XWHB-7**



Uporabniški priročnik  
Uputstva za upotrebu  
User manual

# SI / Uporabniški priročnik

Termostat Saswell SAS908XWHB-7 je žični programski termostat za upravljanje ogrevalnih sistemov. Vse nastavitve temperatur ter sama regulacija se upravlja preko termostata samega. Sistem tudi omogoča nastavitve programske ure ogrevanja za 7, 5+2, 5+1+1 dni in s 4 oz. 6 preklopi na dan.

Navodila za uporabo in vzdrževanje so del splošnih prodajnih pogojev. Pridržujemo si pravico do sprememb detajlov, tehnologije in izvedbe. Garancija velja le skupaj z računom. Dopusčamo možnost napak v tekstu.



## Varovanje narave

Elektronskih naprav in baterij po koncu življenjske dobe ne odlagajte med mešane komunalne odpadke, uporabite zbirna mesta ločenih odpadkov. S pravilno odstranitvijo izdelka boste preprečili negativne vplive na človeško zdravje in okolje. Reciklaža materialov prispeva varstvu naravnih virov. Več informacij o reciklaži tega izdelka Vam ponudijo upravne enote, organizacije za obdelavo gospodinjskih odpadkov ali prodajno mesto, kjer ste izdelek kupili.



## **Pomembna opozorila pred prvo uporabo, namestitvijo in vzdrževanje naprave:**

Pred prvo uporabo pozorno preberite navodila za uporabo ne samo termostata, ampak tudi peči ali klimatske naprave.

- Pred inštalacijo termostata izklopite dovod električnega toka!
- Priporočamo, da inštalacijo opravi kvalificiran delavec!
- Električni krog mora biti zavarovan z varovalko, ki ne presega tokovne obremenitve ožičenja (max 16A).
- Pri montaži upoštevajte vse varnostne predpise
- Izdelka ne izpostavljajte neposredni sončni svetlobi, ekstremnemu mrazu, vlagi in naglim spremembam temperature. To bi znižalo natančnost merjenja temperature
- Izdelka ne nameščajte na mesta, ki so nagnjena k vibracijam in pretresom – to lahko povzroči poškodbe
- Izdelka ne izpostavljajte prekomernemu tlaku, sunkom, prahu, visokim temperaturam ali vlagi saj le te lahko povzročijo poškodbe na kateri izmed funkcij izdelka, krajšo energetske vzdržljivost, poškodbo baterij in deformacije plastičnih delov
- Izdelka ne izpostavljajte dežju ali vlagi, kapljajoči in brizgajoči vodi
- Na izdelek ne postavljajte virov ognja, npr. prižgane svečke ipd.
- Izdelka ne postavljajte na mesta, kjer ni zadostnega kroženja zraka
- V prezračevalne odprtine ne vtikajte nobenih predmetov
- Ne posegajte v notranjo električno napeljavo izdelka – lahko ga poškodujete in s tem prekinite veljavnost garancije. Izdelek sme popravljati le usposobljen strokovnjak
- Za čiščenje uporabljajte zmerno navlaženo blago krpo. Ne uporabljajte raztopin ali čistilnih izdelkov – lahko poškodujejo plastične dele in električno napeljavo
- Izdelka ne potaplajte v vodo ali v druge tekočine
- Pri poškodbah ali napaki izdelka ne popravljajte sami. Predajte ga v popravilo prodajalni, kjer ste ga kupili
- Izdelka ne smejo uporabljati osebe (vključno otrok), ki jih fizična, čutna ali mentalna nesposobnost ali pomanjkanje izkušenj, in znanj ovirajo pri varni uporabi naprave, če pri tem ne bodo nadzorovane, ali če jih o uporabi naprave ni poučila oseba, ki je odgovorna za njihovo varnost
- Nujen je nadzor nad otroki, da bo zagotovljeno, da se ne bodo z napravo igrali.

Za izdelek je bila izdana izjava o skladnosti.

Ta in ostala dokumentacija je dostopna na spletni strani [www.sen-controls.eu](http://www.sen-controls.eu).

Proizvajalec izdelka je SASWELL CONTROLS (HONGKONG) LTD.  
Uvoznik in distributer za Saswell je Sen Controls d.o.o., Belokranjska cesta 29, 8340 Črnomelj, Slovenija

## Lastnosti

- Velik LCD ekran
- Hkratni prikaz trenutne temperature prostora ter nastavljene temperature ogrevanja
- Prikaz ure in trenutnega dneva
- Ohranitev nastavitv urnika ter programa kljub izgubi napajanja
- Opcijski prikaz temperature v Celzijih ali Fahrenheitu
- Možnost vklopa počitniškega delovanja oz. začasne spremembe nastavitve temperature, za večje udobje ter varčevanja z energijo
- Možnost programiranja urnika za vsak dan posebej (7 dni) ali ločene delovne dneve (5 dni) in vikende (2 dni), s štirimi ali šestimi različnimi časovnimi in temperaturnimi nastavitvami
- Možnost kalibracije temperature
- Opozorilo za zamenjavo baterije
- Samodejna zaščita proti zmrzovanju
- Možnost priklopa zunanjega temperaturnega tipala NTC100K, ni nadomesti notranje v termostatu

## Specifikacije enote

Napajanje	220V, baterije 2x AA (LR6) 1.5V (priložene); I <sub>max</sub> 8A(5A)
Merjenje / prikaz temperature	5°C ~ 50°C (natančnost 0.5°C)
Temperatura okolice delovanja	0°C ~50°C
Skladiščna temperatura	-10°C ~ +60°C
Dimenzije	115 x 90 x 32mm

## Hitra navodila

Temperature in vrednosti spreminjate s tipkama ▼ in ▲. Tipka **P** opravlja funkcijo potrditve ali prehoda med meniji. S tipko **R** potrdite funkcije ali končate urejanje nastavitvev.

Spremembe temperatur, časovnih preklpov (ob kateri uri želite preklop) vršite s tipko **P**-kratek pritisk, željena vrednost utripa - spremembo izvršite s tipko ▼ ali ▲. Na naslednji nivo oz. časovni program preidete zopet s kratkim pritiskom na tipko **P**. Če želite takoj zapustiti nastavitve, kratko pritisnete tipko **R**.

V primeru da ste začeli z programiranjem in vam željena vrednost utripa in niste v roku 20 sec pritisnili nobene tipke se vam nastavitvev samodejno shrani.

## Opis termostata – gumbi, stikala in prikaz na ekranu

### Opis gumbov in stikal

1. Vkllop / Zaščita proti zmrzovanju / Izklop
2. Nastavitev ure
3. Nastavitev, uporaba programa (kratak pritisk) / konstantna temp., držanje temperature (dolgi pritisk)
4. Potrditev / izhod
5. Tipka reset
6. Navzgor; Zvišanje vrednosti
7. Navzdol; Znižanje vrednosti

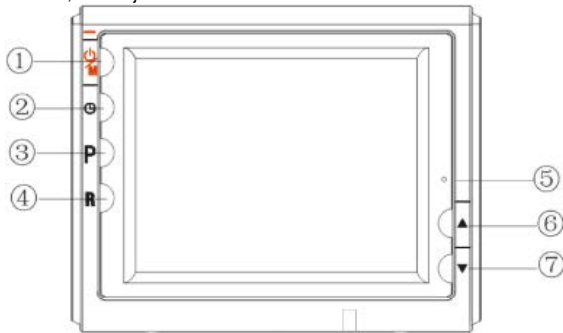

## Opis ekrana

1. Dan oz. dnevi
2. Ura
3. Trenutne nastavitvev
4. Ogrevanje prostora
5. Delovanje (izklopljeno Off ali vklopljeno – sonce)
6. Napaka pri komunikaciji
7. Način upravljanja
8. Načini programa
9. Delovanje ogrevanja (se prižge le če se prostor trenutno ogreva)
10. Enota temperature
11. Način delovanja (program, konstantna temperatura - držanje)
12. Obvestilo za slabe baterije
13. Trenutno nastavljen temperatura ogrevanja
14. Zaklep
15. Trenutna temperatura prostora

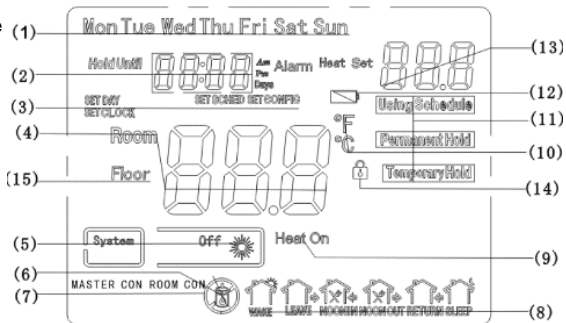

## Namestitev

### Namestitev baterij

Najprej odstranite zadnji pokrov termostata. To storite tako, da z občutkom primete pokrov zgoraj in spodaj in potegnete narazen. Nato pravilno vstavite dve AA (LR6) 1.5V bateriji. Pokrov lahko zaenkrat pustite zunaj, zaradi naslednjega koraka.

**NIKAKOR NE ODPIRAJTE TERMOSTATA NA SILO ALI NA KAKŠNEM DRUGEM MESTU!**

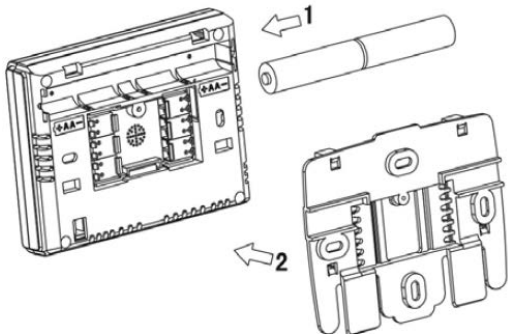
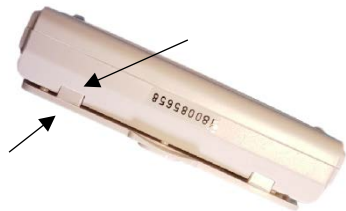



## Montaža

Stensko namestitev opravite tako, da odstranite zadnji pokrov in si označite kje boste izvrtali luknje zanj. Nato pri vijajčite pokrov na označeno mesto in nanj »priprnite« sobno enoto

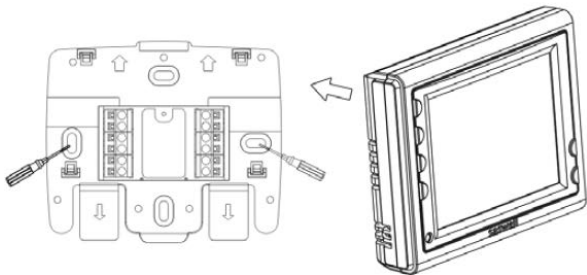

Bodite pozorni, da je termostat montiran na nevtralnem mestu, kjer ni prepiha, vira ogrevanja ali hlajenja, na notranji steni in primerni višini. S tem omogočimo termostatu realen prikaz temperature ter čim boljše delovanje.

Nato izvedite električno vezavo. Ponovno, montažo naj izvede strokovno usposobljena oseba! Glej naslednje strani.

Primeri vezave. Upoštevajte omejitve tokovne obremenitve.

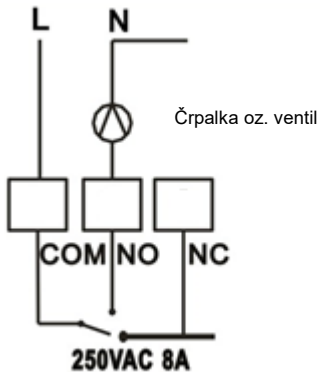

Vezava Črpalka

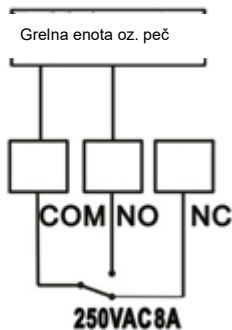

Vezava grelne enote (peči)

Če boste uporabili termostat pri talnem ogrevanju, lahko nanj priključite tudi zunanje tipalo vrednosti NTC100K na kontakte S1, S2, po potrebi lahko uporabite še ozemljitev.

**NIKAKOR NE PRIKLJAPLJAJTE L ter N NA KONTAKTE S1, S2, SAJ S TEM POŠKODUJETE NAPRAVO IN S TEM RAZVELJAVITE GARANCIJO!**

Odstranite varovalo kontaktov. Napajanje ter signalne kable povežite v spodaj prikazani del ohišja. Po končanju vezave, namestite varovalo kontaktov nazaj.

Električna vezava, priklop kontaktov

Opcijsko: priklop zunanje tipala

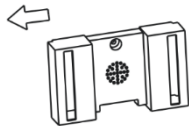
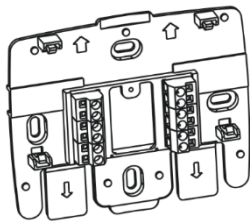
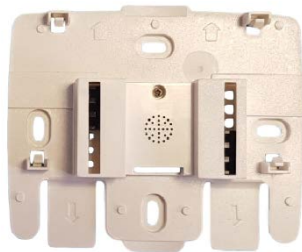
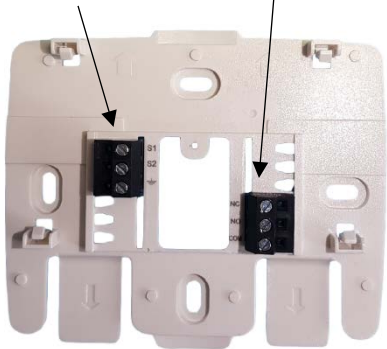

## Prikaz napak





Spodaj je opis treh napak, ki se lahko pojavijo na ekranu ob uporabi naprave:

Napaka / prikaz	Opis
Prikaz prečrtane baterije 	Slabe baterije – potrebna čimprejšnja menjava baterij
roomERR	Okvara temperaturnega tipala
Prikaz na ekranu je popačen, napačen ali ga pa ni	Začasna okvara prikaza. Nežno pritisnite tipko reset.

Namig: Če naprava ne bo v uporabi dalj časa in ni potrebe po ogrevanju, iz nje odstranite baterije in s tem preprečite možnost puščanja baterij ter podaljšate življenjsko dobo baterije.

## Osnovna nastavitve termostata

### Nastavitve ure

Ob pritisku na tipko , se vklopi način urejanja dni in ure. To opazite tudi z utripanjem trenutne pozicije na ekranu. Program vam najprej ponudi urejanje trenutne ure – minute. Vrednost spreminjate s tipkami  ter . Ko ste zadovoljni z nastavitvijo minut, pritisnite tipko , da preidete na urejanje trenutne ure. Ko končate z urejanjem ure, pritisnite tipko  in program vam bo ponudil urejanje trenutnega dneva. Prikaz je v angleščini in sicer po vrstnem redu Mon (ponedeljek), Tue (torek), ... Sat (sobota), Sun (nedelja). Ko končate z urejanjem teh nastavitvev, jih potrdite s tipko **R**.

## Nastavitev programov

S kratkim pritiskom na tipko **P** preidete v način urejanja programov ogrevanja. Pri vsakemu urejanju programov se sklicujete na privzete tabele programov.

Ko ste v načinu urejanja, s tipko **P** prehajate med nastavitvami (dnevi, ura, temperatura, časovni program) in tipkama ▼ ter ▲ spreminjate želene vrednosti (ko izbrana vrednost utripa). Na izbiro imamo dnevne nastavitve za 7, 5+2, 5+1+1 dni ter časovne programe 1-4 oz. 1-6, kot privzeto je pa nastavljen 7 dnevni program s 6 časovnimi programi. Za spremembe se obrnite na napredne nastavitve.

Če nastavitev ne spreminjate, veljajo privzete nastavitve iz spodnjih privzetih tabel programov. Če se zmotite pri nastavitvah programov in jih bi radi vrnili na tovarniško privzete, držite tipko **R** za 3 sekunde med načinom urejanja. Na ekranu utripne prikaz dEF.





**Primer nastavitve privzetega 7 dnevnega časovnega programa s 6 preklopi. Za referenco uporabite tabelo 2 iz poglavja PRIVZETIH TABEL PROGRAMOV**

1. Vstopite v način urejanja s kratkim pritiskom na tipko **P**.
2. Začne utripati dan, nato s tipko ▼ ali ▲ izberete želeni dan katerega želite urediti. Izbiro potrdite s kratkim pritiskom na tipko **P**.
3. Sedaj utripa ura. S tipko ▼ ali ▲ izberete želeno uro za začetek časovnega programa. Izbiro potrdite s kratkim pritiskom na tipko **P**.
4. Sedaj utripa temperatura. S tipko ▼ ali ▲ izberete želeno temperaturo časovnega programa. Izbiro potrdite s kratkim pritiskom na tipko **P**.
5. Sedaj ste končali urejanje prvega od šestih časovnih programov za izbrani dan, utripa ura in s tem začnete urejati naslednji časovni program. S kratkim pritiskom na tipko **R** zaključite urejanje programa ali nadaljujete s kratkim pritiskom na **P** urejanje drugega časovnega programa, po istih korakih od 2-4. Ko končate s šestim časovnim programom preidete na urejanje naslednjega dne po istih korakih 2-4.







Ko ste končate urejanje programov ogrevanja le to potrdite s tipko **R**. V primeru da v roku 30 sekund ne naredite spremembe se shrani zadnja nastavitev.

## Privzete tabele programov (le te lahko preuredite po Vaših željah)

Tabela 1 (7 dni, 4 časovni programi, preklopi)





Ogrevanje	1-Jutro		2-Odhod		3-Prihod		4-Večer	
								
Ponedeljek (Mon)	6:00	21°C	8:00	16.5°C	18 : 00	21°C	22 : 00	16.5°C
Torek (Tue)	6:00	21°C	8:00	16.5°C	18 : 00	21°C	22 : 00	16.5°C
Sreda (Wed)	6:00	21°C	8:00	16.5°C	18 : 00	21°C	22 : 00	16.5°C
Čet (Thu)	6:00	21°C	8:00	16.5°C	18 : 00	21°C	22 : 00	16.5°C
Petek (Fri)	6:00	21°C	8:00	16.5°C	18 : 00	21°C	22 : 00	16.5°C
Sobota (Sat)	6:00	21°C	8:00	16.5°C	18 : 00	21°C	22 : 00	16.5°C
Nedelja (Sun)	6:00	21°C	8:00	16.5°C	18 : 00	21°C	22 : 00	16.5°C





**Tabela 2 (7 dni, 6 časovnih programov, preklopi)**





Ogrevanje	1-Jutro		2-Odhod		3-Malica		4-Popoldan		5-Prihod		6-Večer	
												
Ponedeljek (Mon)	6:00	21 °C	8:00	16.5 °C	12:00	21 °C	14:00	16.5 °C	18:00	21 °C	22:00	16.5 °C
Torek (Tue)	6:00	21 °C	8:00	16.5 °C	12:00	21 °C	14:00	16.5 °C	18:00	21 °C	22:00	16.5 °C
Sreda (Wed)	6:00	21 °C	8:00	16.5 °C	12:00	21 °C	14:00	16.5 °C	18:00	21 °C	22:00	16.5 °C
Čet (Thu)	6:00	21 °C	8:00	16.5 °C	12:00	21 °C	14:00	16.5 °C	18:00	21 °C	22:00	16.5 °C
Petek (Fri)	6:00	21 °C	8:00	16.5 °C	12:00	21 °C	14:00	16.5 °C	18:00	21 °C	22:00	16.5 °C
Sobota (Sat)	6:00	21 °C	8:00	16.5 °C	12:00	21 °C	14:00	16.5 °C	18:00	21 °C	22:00	16.5 °C
Nedelja (Sun)	6:00	21 °C	8:00	16.5 °C	12:00	21 °C	14:00	16.5 °C	18:00	21 °C	22:00	16.5 °C



**Tabela 3 (5 + 1 + 1 dni, 4 časovni programi, preklopi)**

Ogrevanje	1-Jutro		2-Odhod		3-Prihod		4-Večer	
								
Ponedeljek (Mon)	6:00	21°C	8:00	16.5°C	18 : 00	21°C	22 : 00	16.5°C
Torek (Tue)	6:00	21°C	8:00	16.5°C	18 : 00	21°C	22 : 00	16.5°C
Sreda (Wed)	6:00	21°C	8:00	16.5°C	18 : 00	21°C	22 : 00	16.5°C
Čet (Thu)	6:00	21°C	8:00	16.5°C	18 : 00	21°C	22 : 00	16.5°C
Petek (Fri)	6:00	21°C	8:00	16.5°C	18 : 00	21°C	22 : 00	16.5°C

Ogrevanje	1-Jutro		2-Odhod		3-Prihod		4-Večer	
								
Sobota (Sat)	6:00	21°C	8:00	16.5°C	18 : 00	21°C	22 : 00	16.5°C

Ogrevanje	1-Jutro		2-Odhod		3-Prihod		4-Večer	
								
Nedelja (Sun)	6:00	21°C	8:00	16.5°C	18 : 00	21°C	22 : 00	16.5°C





**Tabela 4 (5 + 1 + 1 dni, 6 časovni programi, preklopi)**





Ogrevanje	1-Jutro		2-Odhod		3-Malica		4-Popoldan		5-Prihod		6-Večer	
Ponedeljek (Mon)	6:00	21°C	8:00	16.5°C	12:00	21°C	14:00	16.5°C	18:00	21°C	22:00	16.5°C
Torek (Tue)	6:00	21°C	8:00	16.5°C	12:00	21°C	14:00	16.5°C	18:00	21°C	22:00	16.5°C
Sreda (Wed)	6:00	21°C	8:00	16.5°C	12:00	21°C	14:00	16.5°C	18:00	21°C	22:00	16.5°C
Čet (Thu)	6:00	21°C	8:00	16.5°C	12:00	21°C	14:00	16.5°C	18:00	21°C	22:00	16.5°C
Petek (Fri)	6:00	21°C	8:00	16.5°C	12:00	21°C	14:00	16.5°C	18:00	21°C	22:00	16.5°C

Ogrevanje	1-Jutro		2-Odhod		3-Malica		4-Popoldan		5-Prihod		6-Večer	
Sobota (Sat)	6:00	21°C	8:00	16.5°C	12:00	21°C	14:00	16.5°C	18:00	21°C	22:00	16.5°C







Ogrevanje	1-Jutro		2-Odhod		3-Malica		4-Popoldan		5-Prihod		6-Večer	
Nedelja (Sun)	6:00	21°C	8:00	16.5°C	12:00	21°C	14:00	16.5°C	18:00	21°C	22:00	16.5°C







**Tabela 5 (5 + 2 dni, 4 časovni programi, preklopi)**

Ogrevanje	1-Jutro		2-Odhod		3-Prihod		4-Večer	
								
Ponedeljek (Mon)	6:00	21°C	8:00	16.5°C	18 : 00	21°C	22 : 00	16.5°C
Torek (Tue)	6:00	21°C	8:00	16.5°C	18 : 00	21°C	22 : 00	16.5°C
Sreda (Wed)	6:00	21°C	8:00	16.5°C	18 : 00	21°C	22 : 00	16.5°C
Čet (Thu)	6:00	21°C	8:00	16.5°C	18 : 00	21°C	22 : 00	16.5°C
Petek (Fri)	6:00	21°C	8:00	16.5°C	18 : 00	21°C	22 : 00	16.5°C

Ogrevanje	1-Jutro		2-Odhod		3-Prihod		4-Večer	
								
Sobota (Sat)	6:00	21°C	8:00	16.5°C	18 : 00	21°C	22 : 00	16.5°C
Nedelja (Sun)	6:00	21°C	8:00	16.5°C	18 : 00	21°C	22 : 00	16.5°C

**Tabela 6 (5 + 2 dni, 6 časovnih programov, preklopi)**

Ogrevanje	1-Jutro		2-Odhod		3-Malica		4-Popoldan		5-Prihod		6-Večer	
												
Ponedeljek (Mon)	6:00	21°C	8:00	16.5°C	12:00	21°C	14:00	16.5°C	18:00	21°C	22:00	16.5°C
Torek (Tue)	6:00	21°C	8:00	16.5°C	12:00	21°C	14:00	16.5°C	18:00	21°C	22:00	16.5°C
Sreda (Wed)	6:00	21°C	8:00	16.5°C	12:00	21°C	14:00	16.5°C	18:00	21°C	22:00	16.5°C
Čet (Thu)	6:00	21°C	8:00	16.5°C	12:00	21°C	14:00	16.5°C	18:00	21°C	22:00	16.5°C
Petek (Fri)	6:00	21°C	8:00	16.5°C	12:00	21°C	14:00	16.5°C	18:00	21°C	22:00	16.5°C

Ogrevanje	1-Jutro		2-Odhod		3-Malica		4-Popoldan		5-Prihod		6-Večer	
												
Sobota (Sat)	6:00	21°C	8:00	16.5°C	12:00	21°C	14:00	16.5°C	18:00	21°C	22:00	16.5°C
Nedelja (Sun)	6:00	21°C	8:00	16.5°C	12:00	21°C	14:00	16.5°C	18:00	21°C	22:00	16.5°C

## Napredna nastavitve termostata

Za dostop do napredne nastavitve termostata, izklopite napravo s kratkim pritiskom na tipko  **M**. Naprava mora biti Off (glej opis prikaza 5). Nato držite tipko **P** (3 sekunde) in vstopili boste v napredne nastavitve. Po meniju se pomikate s tipko **P**. Vrednosti spreminjate s tipkami ▼ ter ▲. Pritisnite tipko **R** za shranitev in izhod iz naprednih nastavitvev.

### Razlaga nastavitvev:

Korak	Prikaz na ekranu (tovarniško nastavljena nastavitvev)	Možnosti (vrednost)	Opis
1	CL (0)	-4 do +4	Korekcija prikaza temperature
2	AH (350)	20 – 35 (v °C) 68 – 95 (v °F)	Najvišja delovna temperatura
3	AL (50)	5 – 20 (v °C) 41 – 68 (v °F)	Najnižja delovna temperatura
4	FC (C)	C / F	Prikaz temperature v Celzijih ali Fahrenheitih
5	bL (05)	00 / 05 / 15	Trajanje prikaza osvetlitve v sekundah

Korak	Prikaz na ekranu (tovarniško nastavljena nastavitvev)	Možnosti (vrednost)	Opis
6	db (05)	0.5 – 3.0	Razpon temperature: razpon je temperaturna razlika pri vklopu in izklopu. Če npr. nastavite temperaturo na sistemu na 22°C in razpon na 0.5°C začne ogrevalni sistem delovati če temperatura v prostoru pade na 21.5°C in se izklopi ko temperatura doseže 22.5°C.
7	P51 (7)	0 / 2 / 3 / 7	Opcija programiranja (glej spodnje tabele) 7 : ločena nastavitvev za vsak dan posebej (tabela 1 in 2) 3 : 5 dni + 1 + 1 (tabela 3 in 4) 2 : 5 dni + 2 vikend (tabela 5 in 6) 0 : programi onemogočeni
8	P52 (6)	4 / 6	Število časovnih programom, preklpov: V enem dnevu imamo lahko 4 ali 6 različnih urnih in temperaturnih režimov. (glej zgornje tabele)
9	OC(24)	12 / 24	24 ali 12 urnih prikaz ure
10	ES (OFF)	On / Off	Pametna prilagoditev – Če imate to funkcijo vklopljeno, bo termostat začel delovati že pred preklpom naslednjega programa gretja in poskušal čim bolj udobno ogreti na željeno temperaturo. Če je ta funkcija vklopljena, se naprava ves čas uči in prilagaja ter izračuna, koliko časa prej mora začeti z ogrevanjem.
11	LA (EN)	En / Ch	Izbira jezika – En (angleški) ali Ch (kitajski)

## **Dodatni načini uporabe**

### **Začasna sprememba temperature**

Naprava ima možnost začasne spremembe temperature z opcijo »temporary hold«. Ta opcija se preprosto aktivira z ročno spremembo temperature s tipkami ▼ ali ▲. Če je opcija aktivirana, se vam na ekranu prikaže napis »TEMPORARY HOLD« (glej opis prikaza, št. 11). Željena temperatura ostane aktivna do naslednje spremembe programa (ure). Z gumbom **R** lahko tudi prekličete aktivirano opcijo.

### **Konstantna, stalna sprememba (držanje) temperature**

Naprava ima možnost konstantne spremembe temperature z opcijo »permanent hold«. Opcija vam omogoča neprekinjeno konstantno temperaturo vse dni in ure v tednu, neodvisno od programske nastavitve.

Ta opcija se preprosto aktivira z daljšim pritiskom (5 sekund) na tipko **P**. Če je opcija aktivirana, se vam na ekranu prikaže »PERMANENT HOLD« (glej opis prikaza, št. 11). Željeno temperaturo nastavimo s tipkama ▼ oz. ▲ . Opcija »permanent hold« ostane aktivna dokler je ne prekličemo s kratkim pritiskom na tipko **P** ali **R**.

### **Zaklepanje tipk**

Ta funkcija vam omogoča zaklep termostata in ko je funkcija vklopljena so onemogočene vse morebitne spremembe nastavitvev. Funkcijo aktivirate tako, da istočasno držite tipk ▼ in ▲ za tri sekunde. Ko je funkcija aktivirana, se na zaslonu prikaže simbol ključavnice (glej opis prikaza ekrana – 14). Funkcijo izklopite z daljšim (3 sekunde) pritiskom tipk ▼ in ▲ . Na ekranu izgine simbol ključavnice.

# BIH, HR, SRB / Uputstva za upotrebu

## Bežični termostat SAS908XWHB-7

Termostat Saswell SAS908XWHB-7 je žičani termostat za upravljanje sustava grijanja. Sva temperaturna podešavanja i regulacija se lako upravljaju samim termostatom. Sustav također omogućuje podešavanje programskog sata za 7, 5 + 2, 5 + 1 + 1 dan i 4 ili 6 preklopi na dan.

Uputstva za upotrebu i održavanje su dio opštih uslova prodaje. Zadržavamo pravo izmjene detalja, tehnologije i performansi. Garancija važi samo uz račun. Dozvoljavamo mogućnost grešaka u tekstu.



### Zaštita prirode

Ne stavljajte elektronske proizvode i baterije nakon završetka životne dobi u mješoviti otpad, koristite odlagališta odvojenog otpada. Pravilnim odstranjivanjem proizvoda spriječit ćete negativne učinke na ljudsko zdravlje i okoliš. Recikliranje materijala pridonosi zaštiti prirodnih izvora. Više informacija o recikliranju ovog proizvoda nude vam administrativne jedinice, organizacije za tretman kućanstava ili prodajno mjesto gdje ste kupili proizvod.



## **Važna upozorenja prije korištenja, instalacije i održavanja uređaja po prvi put:**

Prije prvom upotrebom pažljivo pročitajte upute za upotrebu ne samo termostata, nego i peči ili klimatskog uređaja. • Prije instalacije termostata isključite dovod struje! Preporučujemo, da instalaciju izvrši kvalificirani radnik. • Strujni krug mora biti zaštićen osiguračem, koji ne prelazi strujno opterećenje ožičenja (max 16A). • Kod montaže imajte na umu sve sigurnosne regulacije. • Proizvod ne izlažite izravnoj sunčevoj svjetlosti, ekstremnoj hladnoći, vlazi i naglim promjenama temperature. To će smanjiti točnost mjerenja temperature • Ne postavljajte na mjesta koja su podložna vibracijama i udarcima - to može dovesti do oštećenja • Ne izlažite pretjeranom pritisku, udarcima, prašini, visokim temperaturama ili vlažnosti, jer mogu uzrokovati oštećenja na bilo koju od funkcija trajnost proizvoda, oštećenju baterije i deformaciji plastičnih dijelova • ne izlažite kiši ili vlazi • ne stavljajte kod izvora otvorenog plamena, npr. svijeće itd. • Ne stavljajte na mjesto gdje nema dovoljno cirkulacije zraka • kraj ventilacijskih otvora nemojte stavljati nikakve predmete • Ne dirajte unutarnje ožičenje proizvoda - može se oštetiti i time prekinuti jamstvo. • Za sredstvo za čišćenje koristite umjereno navlaženu krpu. Nemojte koristiti otopinu ili proizvode za čišćenje - može oštetiti plastične dijelove i ožičenje • Ne uranjajte u vodu ili druge tekućine • U slučaju oštećenja ili neispravnosti proizvoda ne sami popraviti. Dajte ga u servis gdje ste kupili • Proizvod ne smiju upotrebljavati osobe (uključujući djeca), koje zbog fizičke ili mentalne nesposobnosti ili manjka iskustva nisu sposobne sigurno upravljati uređaj bez potrebe da se ih kontrolira, ili ako ih odgovorna osoba nije uputila u sigurno upravljanje proizvoda. • Dječja kontrola je neophodna kako bi se osiguralo da se ne igraju s uređajem.

Za proizvod je izdana izjava o sukladnosti. Ova i druga dokumentacija dostupne su na adresi [www.sen-controls.eu](http://www.sen-controls.eu). Proizvođač uređaja je SASWELL CONTROLS (HONGKONG) LTD.

Uvoznik i distributer za Saswell je Sen Controls d.o.o., Belokranjska cesta 29, 8340 Črnomelj, Slovenija

## Svojstva

- Veliki LCD ekran
- Simultano prikaz trenutne sobne temperature i podešene temperature grijanja
- Prikaz trenutnog sata i dana
- Održavanje vremenskog rasporeda i postavki programa uprkos gubitku struje
- Opcijski prikaz temperature u Celziju ili Fahrenheitu
- Mogućnost prelaska na rad za odmor ili privremenu promjenu postavki temperature, za veću udobnost i uštedu energije
- Mogućnost programiranja rasporeda za svaki dan (7 dana) ili odvojenih radnih dana (5 dana) i vikenda (2 dana) s četiri ili šest različitih postavki vremena i temperature
- Mogućnost kalibracije temperature
- Upozorenje za zamjenu baterije
- Opcija priklopa eksternog senzora temperature NTC100K, koji zamjeni primarni senzor u termostatu (recimo, za podno grijanje)

## Specifikacije jedinice

Napajanje	220V, baterije 2x AA (LR6) 1.5V (priložene); I <sub>max</sub> 8A(5A)
Mjerenje / prikaz temperature	5°C ~ 50°C oz. (Točnost 0.5°C ili 1°F)
Temperatura okoline	0°C ~50°C
Temperatura skladištenja	-10°C ~ +60°C ili
Dimenzije	115 x 90 x 32mm

## Brze upute

Pritisnite **P**-kratki pritisak da biste promijenili temperaturu, vremensku sklopku (kada želite prebaciti) i pomoću gumba pritisnite za promjenu željene vrijednosti koja treperi.

Promjenu temperature i vremenskih prekidača (kada želite prebaciti) učinite sa gumbom **P**-kratki pritisak, željena vrijednost treperi – promjenu izvršite tipkom ▼ ili ▲. Za promjenu na sljedeću razinu ili vremenski program pritisnite tipku **P** kratko.

Za izlazak iz postavki ili potvrdo pritisnite tipku **R** kratko.

Ako ste započeli s programiranjem, a željena vrijednost treperi i niste u roku od cca. 20 sekundi pritisnuli nijednu tipku, se postavke automatski sahrane.

## Opis termostata - tipke, prekidači i prikaz na zaslonu

### Opis tipki i prekidača

8. Uključeno / zaštita od smrzavanja / isključeno
9. Podešavanje sata
10. Podešavanje pomoću programa (kratki pritisak) / konstantna temp., držanje temperature (dugi pritisak);
11. Potvrda / izlaz;;
12. Reset
13. Gore; Povećajte vrijednost.
14. Dolje; Smanjite vrijednost.

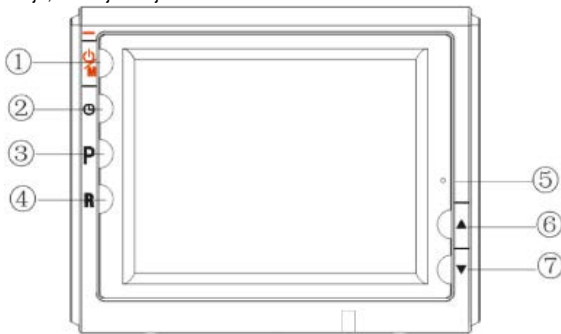

## Opis prikaza ekrana

1. Dan
2. Sat
3. Trenutna postavka
4. Grijanje prostora
5. Rad (isključeno ili uključeno - sunce)
6. Komunikacijska greška
7. Način upravljanja
8. Načini rada programa
9. Rad grijanja (uključuje se samo ako je soba trenutno zagrijana)
10. Temperaturna jedinica
11. Način rada (program, držanje)
12. Obavijest za loše baterije
13. Trenutno postavljena temperatura grijanja
14. Zaključaj
15. Trenutna sobna temperatura

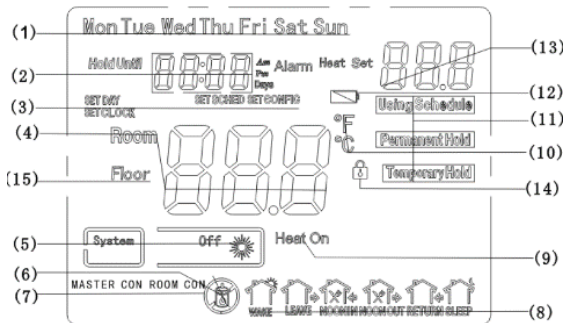

## Instalacija

### Ugradnja baterija u sobnu jединicu

Najprije skinute stražnji poklopac sa termostata. Učinite to tako da osjetite gornji i donji dio poklopca i izvucite je prema van. Zatim stavite dvije AA (LR6) 1.5V baterije ispravno. Poklopac možete ostaviti za trenutak izvan, zbog sljedećeg koraka.

**NE OTVARAJTE TERMOSTATA NA SILU ILI NA KOJEM DRUGOM MJESTU!**

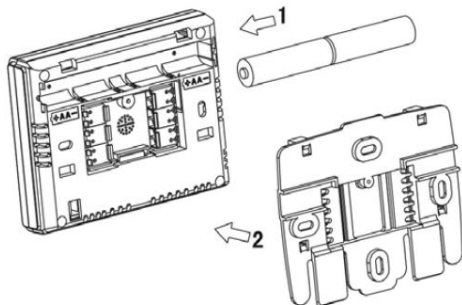

## Ugradnja sobne jedinice

Termostat možete postaviti na zid u željenoj prostoriji.

Izvadite zidnu ugradnju uklonjenjem stražnjeg poklopca i označavajući gdje ćete izbušiti rupe za nju. Zatim, kada pričvrstite poklopac na određeno mjesto i "pričvrstite" sobnu jedinicu.

Postavite termostat na mjesto gdje nije izravno izložena izvoru topline ili sunčevoj svjetlosti (primjer na slici), mrazu, .... na unutarnju stijenu i primjerno visino.

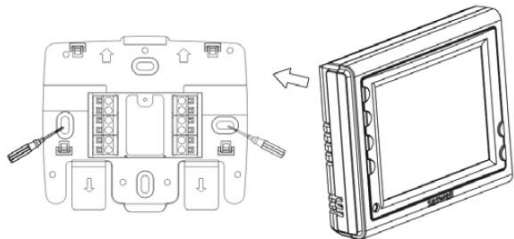

Zatim napravite električnu vezu. Ponovno, montažu treba obaviti kvalificirana osoba!

Primjer vezivanja:

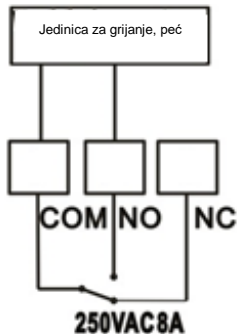
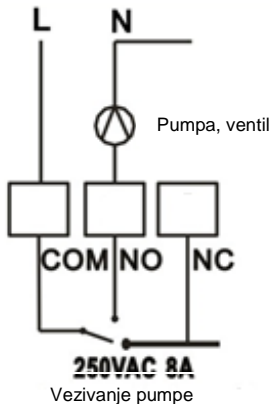

Vezivanje grijaće jedinice (peći)

Ako ćete upotrijebiti termostat kod podnog grijanja, možete priključiti i eksterni senzor tipa NTC100K na kontakte S1, S2.

**U nijednom slučaju ne stavite napon L, N na kontakte S1, S2 jer ćete na taj način oštetiti uređaj i prekinut garanciju!**



Skinite zaštitnik kontakta. Povežite kablove za napajanje i signale sa dijelom kućišta koji je prikazan ispod. Po završetku vezivanja, vratite zaštitnik kontakta. Vratite poklopac na termostatu.

Električni priključak, napon, veza kontakta

Opcija: veza eksternog senzora

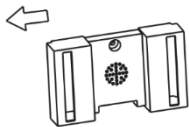
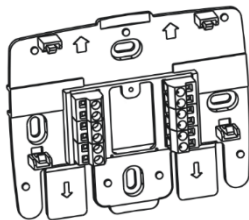
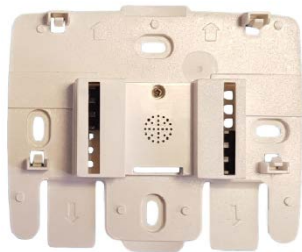
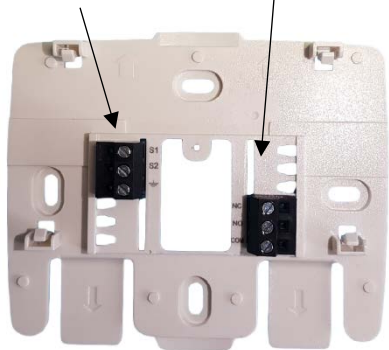

## Prikaz greški





U nastavku je opis tri pogreške koje se mogu pojaviti na zaslonu pri korištenju uređaja:

Pogreška / prikaz	Opis
Prikaz precrtane baterije 	Loše baterije - potrebno je zamijeniti baterije što je prije moguće
roomERR	Pogreška senzora termostata
Nema prikaza na ekranu; prikaz je izobličen, netočan	Privremeni kvar ekrana. Lagano pritisnite tipku za reset.

Savjet: Ako se uređaj ne koristi dugo vremena i nema potrebe po grijanju, izvadite baterije iz baterije kako biste spriječili curenje baterije i produžili trajanje baterije.

## Osnovno podešavanje termostata

### Podešavanje sata

Kada pritisnete tipku , aktivira se način uređivanja dana i sata. To također primijetite tako da treperi trenutni položaj na ekranu. Program će vam najprije ponuditi uređivanje sata i minuta. Vrijednost promijenite pomoću tipki  i . Kada ste zadovoljni postavljanjem minuta, pritisnite tipku  da biste prešli na trenutni sat. Kada završite s uređivanjem sata, pritisnite tipku  i program će vam ponuditi uređivanje tekućeg dana. Prikaz je na engleskom jeziku po redoslijedu ponedjeljak (mon), utorak (tue), ... subota (sat), nedjelja (sun). Kada završite s uređivanjem ovih postavki, potvrdite tipkom **R**.

## Podešavanje programa

Kratkim pritiskom tipke **P** prebacujete se u način uređivanja programa grijanja. Za svaki program za uređivanje, pogledajte zadane tablice programa.

Kada ste u uređivanju, možete koristiti tipku **P** za prebacivanje između postavki (dani, sat, temperatura, program) i tipkama **▼** i **▲** promijenite željene vrijednosti (kada treperi odabrana vrijednost). Imamo izbor postavki dana za 7, 5 + 2, 5 + 1 + 1 dana i vremenske programe od 1-4 ili 1-6 i 7-dnevni program s 6 vremenskih programa postavljen je kao zadani. Za izmjene, obratite se naprednim postavkama.

Ako ne promijenite postavku, zadane su postavke zadane vrijednosti zadane tablice programa. Ako pogriješite u postavkama programa i želite ih vratiti na tvorničke postavke, držite tipku **R** na 3 sekunde tijekom moda uređivanja. DEF treperi na zaslonu.





## **Primjer postavljanja zadanog programa od 7 dana sa 6 preklopima. Za referencu koristite tablicu 2 poglavlja ZADANIH PROGRAMA**

6. Unesite način uređivanja tako da kratko pritisnete tipku **P**.
7. Kad trepće dan, pritisnite ▼ ili ▲ da biste odabrali dan koji želite urediti. Potvrdite odabir kratkim pritiskom na tipku **P**.
8. Sada trepće vrijeme. Pomoću tipke ▼ ili ▲ odaberite željeno vrijeme za pokretanje vremenskog programa. Potvrdite odabir kratkim pritiskom na tipku **P**.
9. Temperatura trepće. Pritisnite tipku ▼ ili ▲ da odaberete željenu temperaturu vremenskog programa. Potvrdite odabir tako da kratko pritisnete tipku **P**.
10. Sada ste završili s uređivanjem prvog od šest programa za odabrani dan, sat trepće, a sljedeći put započinje program. Kratko pritiskom na tipku **R**, možete završiti uređivanje programa ili nastaviti tako da kratko pritisnete **P** za uređivanje drugog vremenskog programa, slijedeći iste korake od 2-4. Kada završite s programom šesti, prebacit ćete se na uređivanje sljedećeg dana nakon istih koraka 2-4. Kada završite s uređivanjem programa grijanja, samo potvrdite tipkom **R**. Ako ne izvršite promjenu unutar 30 sekundi, zadnja postavka se sprema.







Kada završite s uređivanjem programa grijanja, samo potvrdite tipkom **R**. Ako ne izvršite promjenu unutar 30 sekundi, zadnja postavka se sprema.

## Zadane tabele programa (možete ih preurediti prema Vašim željama)





Tabela 1 (7 dana, 4 vremenska programa, preklopa)





Grijanje	1-Jutro		2- Odlazak		3- Dolazak		4- Večer	
								
Ponedjeljak (Mon)	6:00	21°C	8:00	16.5°C	18 : 00	21°C	22 : 00	16.5°C
Utorak (Tue)	6:00	21°C	8:00	16.5°C	18 : 00	21°C	22 : 00	16.5°C
Srijeda (Wed)	6:00	21°C	8:00	16.5°C	18 : 00	21°C	22 : 00	16.5°C
Četvrtak (Thu)	6:00	21°C	8:00	16.5°C	18 : 00	21°C	22 : 00	16.5°C
Petak (Fri)	6:00	21°C	8:00	16.5°C	18 : 00	21°C	22 : 00	16.5°C
Subota (Sat)	6:00	21°C	8:00	16.5°C	18 : 00	21°C	22 : 00	16.5°C
Nedjelja (Sun)	6:00	21°C	8:00	16.5°C	18 : 00	21°C	22 : 00	16.5°C





**Tabela 2 (7 dana, 6 vremenskih programa, preklopa)**

Grijanje	1- Jutro		2- Odlazak		3- Ručak		4- Popodne		5- Dolazak		6- Večer	
												
Ponedjeljak (Mon)	6:00	21°C	8:00	16.5°C	12:00	21°C	14:00	16.5°C	18:00	21°C	22:00	16.5°C
Utorak (Tue)	6:00	21°C	8:00	16.5°C	12:00	21°C	14:00	16.5°C	18:00	21°C	22:00	16.5°C
Srijeda (Wed)	6:00	21°C	8:00	16.5°C	12:00	21°C	14:00	16.5°C	18:00	21°C	22:00	16.5°C
Četvrtak (Thu)	6:00	21°C	8:00	16.5°C	12:00	21°C	14:00	16.5°C	18:00	21°C	22:00	16.5°C
Petak (Fri)	6:00	21°C	8:00	16.5°C	12:00	21°C	14:00	16.5°C	18:00	21°C	22:00	16.5°C
Subota (Sat)	6:00	21°C	8:00	16.5°C	12:00	21°C	14:00	16.5°C	18:00	21°C	22:00	16.5°C
Nedjelja (Sun)	6:00	21°C	8:00	16.5°C	12:00	21°C	14:00	16.5°C	18:00	21°C	22:00	16.5°C







**Tabela 3 (5 + 1 + 1 dana, 4 vremenska programa, preklopa)**







Grijanje	1- Jutro		2- Odlazak		3- Dolazak		4- Večer	
								
Ponedjeljak (Mon)	6:00	21°C	8:00	16.5°C	18 : 00	21°C	22 : 00	16.5°C
Utorak (Tue)	6:00	21°C	8:00	16.5°C	18 : 00	21°C	22 : 00	16.5°C
Srijeda (Wed)	6:00	21°C	8:00	16.5°C	18 : 00	21°C	22 : 00	16.5°C
Četvrtak (Thu)	6:00	21°C	8:00	16.5°C	18 : 00	21°C	22 : 00	16.5°C
Petak (Fri)	6:00	21°C	8:00	16.5°C	18 : 00	21°C	22 : 00	16.5°C







Grijanje	1- Jutro		2- Odlazak		3- Dolazak		4- Večer	
								
Subota (Sat)	6:00	21°C	8:00	16.5°C	18 : 00	21°C	22 : 00	16.5°C

Grijanje	1- Jutro		2- Odlazak		3- Dolazak		4- Večer	
								
Nedjelja (Sun)	6:00	21°C	8:00	16.5°C	18 : 00	21°C	22 : 00	16.5°C

**Tabela 4 (5 + 1 + 1 dana, 6 vremenskih programa, preklopa)**





Grijanje	1- Jutro		2- Odlazak		3- Ručak		4- Popodne		5- Dolazak		6- Večer	
												
Ponedjeljak (Mon)	6:00	21°C	8:00	16.5°C	12:00	21°C	14:00	16.5°C	18:00	21°C	22:00	16.5°C
Utorak (Tue)	6:00	21°C	8:00	16.5°C	12:00	21°C	14:00	16.5°C	18:00	21°C	22:00	16.5°C
Srijeda (Wed)	6:00	21°C	8:00	16.5°C	12:00	21°C	14:00	16.5°C	18:00	21°C	22:00	16.5°C
Četvrtak (Thu)	6:00	21°C	8:00	16.5°C	12:00	21°C	14:00	16.5°C	18:00	21°C	22:00	16.5°C
Petak (Fri)	6:00	21°C	8:00	16.5°C	12:00	21°C	14:00	16.5°C	18:00	21°C	22:00	16.5°C



Grijanje	1- Jutro		2- Odlazak		3- Ručak		4- Popodne		5- Dolazak		6- Večer	
												
Subota (Sat)	6:00	21°C	8:00	16.5°C	12:00	21°C	14:00	16.5°C	18:00	21°C	22:00	16.5°C

Grijanje	1- Jutro		2- Odlazak		3- Ručak		4- Popodne		5- Dolazak		6- Večer	
												
Nedjelja (Sun)	6:00	21°C	8:00	16.5°C	12:00	21°C	14:00	16.5°C	18:00	21°C	22:00	16.5°C















**Tabela 5 (5 + 2 dana, 4 vremenska programa, preklopa)**

Grijanje	1- Jutro		2- Odlazak		3- Dolazak		4- Večer	
								
Ponedjeljak (Mon)	6:00	21°C	8:00	16.5°C	18 : 00	21°C	22 : 00	16.5°C
Utorak (Tue)	6:00	21°C	8:00	16.5°C	18 : 00	21°C	22 : 00	16.5°C
Srijeda (Wed)	6:00	21°C	8:00	16.5°C	18 : 00	21°C	22 : 00	16.5°C
Četvrtak (Thu)	6:00	21°C	8:00	16.5°C	18 : 00	21°C	22 : 00	16.5°C
Petak (Fri)	6:00	21°C	8:00	16.5°C	18 : 00	21°C	22 : 00	16.5°C

Grijanje	1- Jutro		2- Odlazak		3- Dolazak		4- Večer	
								
Subota (Sat)	6:00	21°C	8:00	16.5°C	18 : 00	21°C	22 : 00	16.5°C
Nedjelja (Sun)	6:00	21°C	8:00	16.5°C	18 : 00	21°C	22 : 00	16.5°C

**Tabela 6 (5 + 2 dana, 6 vremenskih programa, preklopa)**

Grijanje	1- Jutro		2- Odlazak		3- Ručak		4- Popodne		5- Dolazak		6- Večer	
												
Ponedjeljak (Mon)	6:00	21°C	8:00	16.5°C	12:00	21°C	14:00	16.5°C	18:00	21°C	22:00	16.5°C
Utorak (Tue)	6:00	21°C	8:00	16.5°C	12:00	21°C	14:00	16.5°C	18:00	21°C	22:00	16.5°C
Srijeda (Wed)	6:00	21°C	8:00	16.5°C	12:00	21°C	14:00	16.5°C	18:00	21°C	22:00	16.5°C
Četvrtak (Thu)	6:00	21°C	8:00	16.5°C	12:00	21°C	14:00	16.5°C	18:00	21°C	22:00	16.5°C
Petak (Fri)	6:00	21°C	8:00	16.5°C	12:00	21°C	14:00	16.5°C	18:00	21°C	22:00	16.5°C

Grijanje	1- Jutro		2- Odlazak		3- Ručak		4- Popodne		5- Dolazak		6- Večer	
												
Subota (Sat)	6:00	21°C	8:00	16.5°C	12:00	21°C	14:00	16.5°C	18:00	21°C	22:00	16.5°C
Nedjelja (Sun)	6:00	21°C	8:00	16.5°C	12:00	21°C	14:00	16.5°C	18:00	21°C	22:00	16.5°C

## Napredne postavke termostata

Da biste pristupili naprednim postavkama termostata, isključite uređaj kratkim pritiskom na tipku  **M**. Uređaj mora biti isključen – OFF (vidi opis opisa, br. 5). Zatim pritisnite tipku **P** (3 sekunde) da bi ušli u napredne postavke. Pritisnite tipku **P** za pomicanje izbornika. Vrijednosti možete promijeniti pomoću tipki **▼** i **▲**. Pritisnite tipku **R** za spremanje i izlazak iz naprednih postavki (izlaz iz uređivanja).

### Objašnjenje postavki:

Korak	Prikaz na ekranu (tvorničke postavke)	Opcije (Vrijednosti)	Opis
1	CL (0)	-4 do +4	Ispravljanje prikaza temperature
2	AH (350)	20 – 35 (v °C) 68 – 95 (v °F)	Najviša temperatura rada
3	AL (50)	5 – 20 (v °C) 41 – 68 (v °F)	Najniža temperatura rada
4	FC (C)	C / F	Prikaz temperature u Celzijusu ili Fahrenheitu
5	bL (05)	00 / 05 / 15	Trajanje dužine osvjjetljenja u sekundama

Korak	Prikaz na ekranu (tvorničke postavke)	Opcije (Vrijednosti)	Opis
6	db (05)	0.5 – 3.0	Diferencija / Histereza Raspon temperature: raspon je razlika temperature između uključivanja i isključivanja. Ako, na primjer, postavite temperaturu na sustav na 22 ° C, a raspon od 0,5 ° C pokreće sustav grijanja da radi ako sobna temperatura padne na 21,5 ° C i isključuje se kada temperatura dosegne 22,5 ° C.
7	P51 (7)	0 / 2 / 3 / 7	Mogućnost programiranja (pogledajte tablice u nastavku) 7: Odvojena postavka za svaki dan (tablica 1 i 2) 3: 5 dana + 1 + 1 (tablice 3 i 4) 2: 5 dana + 2 vikenda (tablice 5 i 6) 0: programi su onemogućeni
8	P52 (6)	4 / 6	Broj vremenskih programa, preklopa: U jednom danu možemo imati 4 ili 6 različitih satnih i temperaturnih režima. (pogledajte tablice u nastavku)
9	OC(24)	12 / 24	24 sata ili 12 sati prikaz sata
10	ES (OFF)	On / Off	Pametno podešavanje - Ako je ova značajka uključena, termostat će početi raditi prije uključivanja nasljednog programa grijanja i pokušat će postići željenu temperaturu što je više udobno. Ako je ova funkcija uključena, uređaj stalno uči i podešava i izračunava koliko dugo mu treba da počinje sa grijanjem.
11	LA (EN)	En / Ch	Odabir jezika - En (engleski) ili Ch (kineski)

## Dodatne namjene

### Privremena promjena temperature

Uređaj ima mogućnost privremeno mijenjati temperaturu s opcijom "privremeno zadržavanje". Ova se opcija jednostavno aktivira ručnim promjenom temperature pomoću tipki ▼ ili ▲. Ako je opcija uključena, na zaslonu će se pojaviti "TEMPORARY HOLD" (vidi opis opisa, br. 11). Željena temperatura ostaje aktivna dok se sljedeći program ne promijeni (sati). Sa pritiskom na tipku **R** možete otkazati aktiviranu opciju.

### Konstantna promjena temperature

Uređaj ima mogućnost stalne promjene temperature uz opciju "trajno držanje". Opcija vam omogućuje da neprekidno konstantnu temperaturu održavate svaki dan i sat tjedna, neovisno o postavkama programa.

Ova se opcija jednostavno aktivira pritiskom na tipku **P** (5 sekundi). Ako je opcija uključena, na zaslonu će se pojaviti "PERMANENT HOLD" (vidi opis opisa br. 11). Podesite željenu temperaturu pomoću ▼ ili ▲. Opcija "trajno zadržavanje" ostaje aktivna sve dok se ne poništi kratko pritiskom na tipku **P** ili **R**.

### Zaključavanje tipki

Ova postavka omogućuje zaključavanje termostata, a kad je funkcija uključena, sve promjene postavki su onemogućene. Aktivirajte funkciju istovremeno držanjem tipki ▼ i ▲ istovremeno tri sekunde. Kada je funkcija aktivirana, prikazan je simbol zaključavanja (pogledajte opis zaslona - 14). Isključite funkciju duže (3 sekunde) pritiskom na tipke ▼ i ▲. Simbol zaključavanja nestaje na ekranu.

# EN / *User manual*

Thermostat Saswell SAS908XWHB-7 is a wired thermostat for managing the heating systems. All temperature settings and the regulation itself is easily controlled via the thermostat. The system also allows programming of the heating schedule clock for 7, 5 + 2, 5 + 1 + 1 days and 4 oz. 6 switches per day.

The instructions for use and maintenance are part of the general terms and conditions of sale. We reserve the right to change the details, technology and performance. The guarantee is valid only with the original invoice. We allow the possibility of errors in the text.



## **Environment protection**

Do not place electronic devices and batteries after the end of their life in mixed municipal waste, use collection points of separate waste. By properly removing the product, you will prevent negative effects on human health and the environment. Recycling of materials contributes to the protection of natural resources. More information on the recycling of this product is offered to you by administrative units, household waste treatment organizations or the point of sale where you purchased the product.

**Important notes before first use, installation and maintenance:**

Before use, carefully read the manual not only for the thermostat, but also for the heating device (heat pump, etc.) • Turn off the power supply before installing the thermostat! • We recommend that the installation is done by a qualified electrician • the electrical circuit must be secured with a fuse that does not exceed the current load of wiring (max 16A) • Please note all safety instructions before installing • Do not expose the product to direct sunlight, extreme cold, humidity and sudden temperature changes. This would reduce the accuracy of the temperature measurement • Do not place the product in places that are prone to vibrations and shocks - this can cause damage • Do not expose the product to excessive pressure, shock, dust, high temperatures or moisture, as these can cause damage to one of the functions product, shorter energy endurance, damage to batteries, and deformation of plastic parts. • Do not expose the product to rain or moisture, dripping or spraying water. • Do not place any sources of fire on the product, for example, spark plugs etc. • Do not place the product in places where there is insufficient air circulation. • Do not insert any objects into the ventilation openings. • Do not interfere with the internal electrical wiring of the product. It may be damaged and therefore terminate the warranty. The product must only be repaired by a trained specialist. • Use a moderately moistened cloth for cleaning. Do not use solutions or cleaning products - may damage plastic parts and electrical wiring • Do not immerse the product in water or other liquids. • Do not repair it yourself if the product is damaged or defective. Put it in the repair shop where you bought it • The product should not be used by a person (including children) by physical, sensory or mental disability or lack of experience and knowledge impeded by the safe use of the device if they are not controlled, or if they were not informed by the person responsible for their safety about the use of the device • Children's control is necessary to ensure that they do not play with the device.

Declaration of conformity has been issued for the product. This and other documentation is available on the website [www.sen-controls.eu](http://www.sen-controls.eu).

The manufacturer of this product is SASWELL CONTROLS (HONGKONG) LTD.

Importer and distributor for Saswell is Sen Controls d.o.o., Belokranjska cesta 29, 8340 Črnomelj, Slovenia

## Features

- Large LCD display
- Simultaneous display of the current room temperature and the set heating temperature
- Display of the current hour and day
- Preserving schedule and program settings despite power loss
- Temperature display in Celsius or Fahrenheit
- Holiday, temporary hold and constant, permanent hold modes for power saving or greater comfort
- Program scheduling for each day (7 days) or separate working days (5 days) and weekends (2 days), with four or six different time and temperature settings
- Temperature calibration
- Battery replacement warning
- Smart adaption function
- Antifreeze function
- Option of attaching an external temperature sensor NTC100K for underfloor or other intentions. If in use, the internal temperature sensor is disabled.

## Specifications of the thermostat unit

Power supply	2x AA (LR6) 1.5V batteries (included); I <sub>max</sub> 8A(5A)
Room temperature setting range	5°C ~ 50°C oz. (accuracy 0.5°C)
Ambient temperature	0°C ~50°C
Transport or warehouse temperature	-10°C ~ +60°C oz.
Dimensions	115 x 90 x 32mm



## Quick start and tips

Temperature changing, programming switches (at what hour the switch should occur) and all confirmations are done by short pressing button **P**, when the value is blinking. You can change the values, when they are blinking, by pressing buttons **▼** (decrease value) or **▲** (increase value) and again confirming the values by short pressing button **P**. To exit any editing just short press the button **R**. All values, settings will be saved.

Also if you are editing settings or configuring the device and you don't press any button for 20 seconds, the device will exit the current editing and save its current values.

## Transmitter (thermostat) – Button descriptions

### Button description

1. On / Frost protection / Off (stand by)
2. Setting the clock
3. Setting the programs (short press/ Hold, constant temperature (long press))
4. Confirm / Exit
5. Reset button
6. Up; Increase value
7. Down; Reduce value

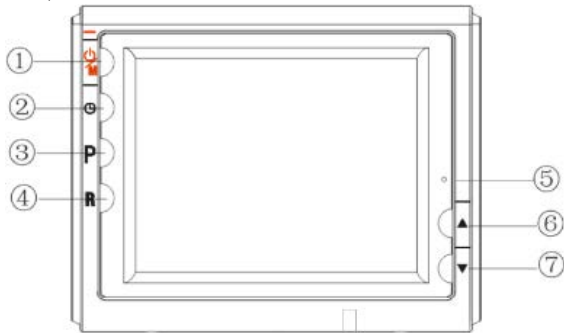

## Display description

1. Date, day
2. Hour
3. Current selected setting
4. Heating
5. Operation (Off or if turned on the sun symbol will be lit)
6. Communication error
7. Control mode
8. Program mode
9. Heating operation (turns on only if the room is currently heating)
10. Temperature unit
11. Mode of operation (program, hold)
12. Battery replacement warning
13. The currently set heating temperature
14. Keyboard lock
15. Current room temperature

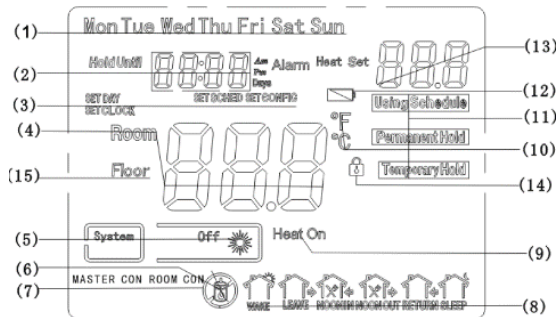

## Installation

### Battery installation

First remove the rear cover from the thermostat. Do this by carefully pulling the cover from the top and bottom of the cover and pull it outwards. Then insert two AA (LR6) 1.5V batteries the correct polarity. You can leave the cover until the next step.

Do not open the thermostat anywhere else or in any other way other than shown in this manual or with force!

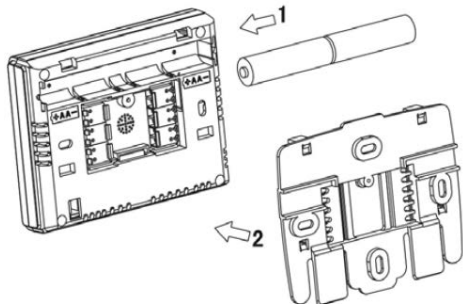

## Installation

You can place the thermostat on the wall in the desired room.

Perform the wall mounting by removing the back cover and marking where you will drill holes for it. Then, screw the cover into the designated, marked place and "attach" the room unit. Place the thermostat in a location where it is not directly exposed to a heat source or to sunlight (example in the picture).

Make sure that the thermostat is placed on a neutral position, not near a heating or cooling source, on an inside wall and on a proper height. Doing so, we allow the thermostat to work properly.

After you've completed this step, preform electrical wiring. Once again, the assembly / installation should be carried out by a qualified person!

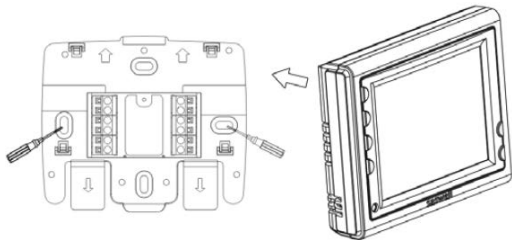

An example of an electrical scheme.

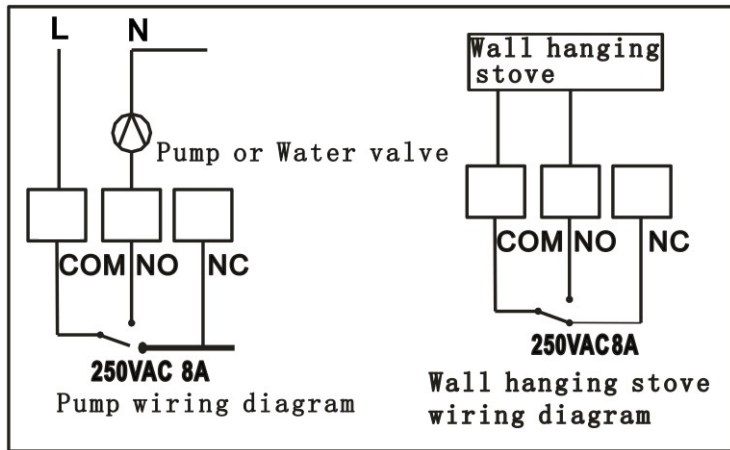

If you're using the thermostat for underfloor heating, you can install an external temperature sensor with value NTC100K on contacts S1, S2. If an external sensor is attached, the internal will be disabled so only one can work at the same time. **In no case you should attach electrical wirings of L and N to S1 or S2 contacts!! Warranty will be void!**

Remove the safety contacts. Connect power and signal cables to the housing section shown below. After completion of assembly, install safety of the contacts back on the housing.

Electrical wiring with scheme

Optional: contacts for external sensor

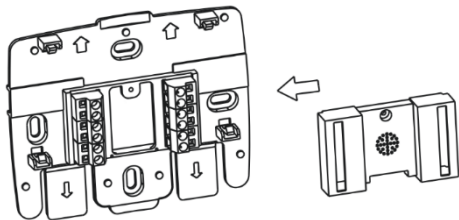
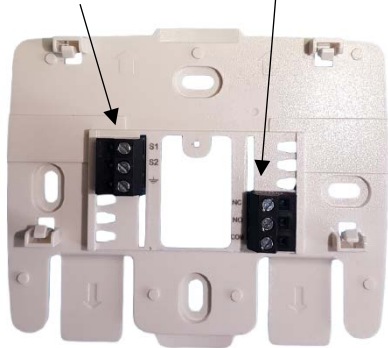

## On display troubleshooting

Short description of possible errors, the device might show on the display:

Error shown on display	Description
Crossed battery 	Bad batteries - requires the replacement of batteries as soon as possible.
roomERR	Thermostat sensor failure.
No display or the display is malfunctioning	Temporary display malfunction. Press reset button softly.

Tip: If the device is not in use for a long time and there is no need for heating, remove the batteries to prevent battery leakage and extend the battery life.



## **Basic thermostat setting**

### **Setting the clock**

Pressing the **⌚** button enters the clock and day setting mode. When in editing mode, the current setting position will blink. First you are setting the time – hours and minutes. You can change the value by pressing **▼** or **▲** buttons. When you are done setting the time, press the **⌚** button and you will continue to setting the current day. Again, you change the value by pressing **▼** or **▲** buttons. When you are done setting the time/date values, press the **R** button to exit and save.

### **Programming the heating modes and schedules**

By short pressing the **P** key, you enter heating mode programming. For every program and schedule you can look up to the default tables on the next pages.

When you are in editing mode, you can use the **P** button to switch between the settings (days, clock, temperature and timer) and **▼** or **▲** keys to change the desired values (when the selected value flashes).

We can choose the settings for 7, 5 + 2, 5 + 1 + 1 days and 4 or 6 time switches. As the default program schedule setting is set the 7-day program with 6 time programs. For changing these values, please refer to advanced settings.

If you won't change any of the schedules, the default settings will stay. For reference, check the tables in the next pages.

If you are not happy with your settings you've made, you can always set them back to factory default by holding button **R** for 3 seconds. All changes made to the schedules will be lost and set to factory default! The display will show dEF.

When editing, if you don't press any button for about 15 seconds, the device will save any changes made until then. You can return to editing by going back with the same procedure.

**Example of setting the default 7 day schedule with 6 switches. Check table two for reference.**





1. Enter the editing mode by briefly pressing the **P** button.
2. The day flashes, then press ▼ or ▲ to select the day you want to edit. Confirm the selection by briefly pressing the **P** button.
3. The time is blinking now. Press ▼ or ▲ key to select the desired time to start the time program. Confirm the selection by briefly pressing the **P** button.
4. The temperature is now flashing. Press ▼ or ▲ button to select the desired temperature of the time program. Confirm the selection by briefly pressing the **P** button.
5. Now you have finished editing the first of the six time programs for the selected day, the clock is flashing, and the next time program (switch) editing is started. By briefly pressing the **R** key, you can finish editing the program / schedule or continue by briefly pressing **P** to edit another time program, following the same steps from 2-4.

When you are finished with the sixth time program, you will switch to editing the next day after the same steps 2-4.







Once you have finished editing the heating programs, just confirm with briefly pressing the **R** key. If you do not make any changes within 30 seconds all the settings are saved.

## Default program schedules (you can rearrange them according to your wishes)





Table 1 (7 days, 4 hourly/time switches)





Heating	1-Morning		2-Work		3-Came back		4-Night	
								
Monday	6:00	21°C	8:00	16.5°C	18 : 00	21°C	22 : 00	16.5°C
Tuesday	6:00	21°C	8:00	16.5°C	18 : 00	21°C	22 : 00	16.5°C
Wednesday	6:00	21°C	8:00	16.5°C	18 : 00	21°C	22 : 00	16.5°C
Thursday	6:00	21°C	8:00	16.5°C	18 : 00	21°C	22 : 00	16.5°C
Friday	6:00	21°C	8:00	16.5°C	18 : 00	21°C	22 : 00	16.5°C
Saturday	6:00	21°C	8:00	16.5°C	18 : 00	21°C	22 : 00	16.5°C
Sunday	6:00	21°C	8:00	16.5°C	18 : 00	21°C	22 : 00	16.5°C





**Table 2 (7 days, 6 hourly/time switches)**

Heating	1-Morning		2-Work		3-Lunch		4-Afternoon		5-Came back		6-Night	
												
Monday	6:00	21°C	8:00	16.5°C	12:00	21°C	14:00	16.5°C	18:00	21°C	22:00	16.5°C
Tuesday	6:00	21°C	8:00	16.5°C	12:00	21°C	14:00	16.5°C	18:00	21°C	22:00	16.5°C
Wednesday	6:00	21°C	8:00	16.5°C	12:00	21°C	14:00	16.5°C	18:00	21°C	22:00	16.5°C
Thursday	6:00	21°C	8:00	16.5°C	12:00	21°C	14:00	16.5°C	18:00	21°C	22:00	16.5°C
Friday	6:00	21°C	8:00	16.5°C	12:00	21°C	14:00	16.5°C	18:00	21°C	22:00	16.5°C
Saturday	6:00	21°C	8:00	16.5°C	12:00	21°C	14:00	16.5°C	18:00	21°C	22:00	16.5°C
Sunday	6:00	21°C	8:00	16.5°C	12:00	21°C	14:00	16.5°C	18:00	21°C	22:00	16.5°C







**Table 3 (5 + 1 + 1 days, 4 hourly/time switches)**







Heating	1-Morning		2-Work		3-Came back		4-Night	
								
Monday	6:00	21°C	8:00	16.5°C	18 : 00	21°C	22 : 00	16.5°C
Tuesday	6:00	21°C	8:00	16.5°C	18 : 00	21°C	22 : 00	16.5°C
Wednesday	6:00	21°C	8:00	16.5°C	18 : 00	21°C	22 : 00	16.5°C
Thursday	6:00	21°C	8:00	16.5°C	18 : 00	21°C	22 : 00	16.5°C
Friday	6:00	21°C	8:00	16.5°C	18 : 00	21°C	22 : 00	16.5°C







Heating	1-Morning		2-Work		3-Came back		4-Night	
								
Saturday	6:00	21°C	8:00	16.5°C	18 : 00	21°C	22 : 00	16.5°C

Heating	1-Morning		2-Work		3-Came back		4-Night	
								
Sunday	6:00	21°C	8:00	16.5°C	18 : 00	21°C	22 : 00	16.5°C





**Table 4 (5 + 1 + 1 days, 6 hourly/time switches)**





Heating	1-Morning		2-Work		3-Lunch		4-Afternoon		5-Came back		6-Night	
												
Monday	6:00	21°C	8:00	16.5°C	12:00	21°C	14:00	16.5°C	18:00	21°C	22:00	16.5°C
Tuesday	6:00	21°C	8:00	16.5°C	12:00	21°C	14:00	16.5°C	18:00	21°C	22:00	16.5°C
Wednesday	6:00	21°C	8:00	16.5°C	12:00	21°C	14:00	16.5°C	18:00	21°C	22:00	16.5°C
Thursday	6:00	21°C	8:00	16.5°C	12:00	21°C	14:00	16.5°C	18:00	21°C	22:00	16.5°C
Friday	6:00	21°C	8:00	16.5°C	12:00	21°C	14:00	16.5°C	18:00	21°C	22:00	16.5°C

Heating	1-Morning		2-Work		3-Lunch		4-Afternoon		5-Came back		6-Night	
												
Saturday	6:00	21°C	8:00	16.5°C	12:00	21°C	14:00	16.5°C	18:00	21°C	22:00	16.5°C







Heating	1-Morning		2-Work		3-Lunch		4-Afternoon		5-Came back		6-Night	
												
Sunday	6:00	21°C	8:00	16.5°C	12:00	21°C	14:00	16.5°C	18:00	21°C	22:00	16.5°C







**Table 5 (5 + 2 days, 4 hourly/time switches)**

Heating	1-Morning		2-Work		3-Came back		4-Night	
								
Monday	6:00	21°C	8:00	16.5°C	18 : 00	21°C	22 : 00	16.5°C
Tuesday	6:00	21°C	8:00	16.5°C	18 : 00	21°C	22 : 00	16.5°C
Wednesday	6:00	21°C	8:00	16.5°C	18 : 00	21°C	22 : 00	16.5°C
Thursday	6:00	21°C	8:00	16.5°C	18 : 00	21°C	22 : 00	16.5°C
Friday	6:00	21°C	8:00	16.5°C	18 : 00	21°C	22 : 00	16.5°C

Heating	1-Morning		2-Work		3-Came back		4-Night	
								
Saturday	6:00	21°C	8:00	16.5°C	18 : 00	21°C	22 : 00	16.5°C
Sunday	6:00	21°C	8:00	16.5°C	18 : 00	21°C	22 : 00	16.5°C

**Table 6 (5 + 2 days, 6 hourly/time switches)**

Heating	1-Morning		2-Work		3-Lunch		4-Afternoon		5-Came back		6-Night	
												
Monday	6:00	21°C	8:00	16.5°C	12:00	21°C	14:00	16.5°C	18:00	21°C	22:00	16.5°C
Tuesday	6:00	21°C	8:00	16.5°C	12:00	21°C	14:00	16.5°C	18:00	21°C	22:00	16.5°C
Wednesday	6:00	21°C	8:00	16.5°C	12:00	21°C	14:00	16.5°C	18:00	21°C	22:00	16.5°C
Thursday	6:00	21°C	8:00	16.5°C	12:00	21°C	14:00	16.5°C	18:00	21°C	22:00	16.5°C
Friday	6:00	21°C	8:00	16.5°C	12:00	21°C	14:00	16.5°C	18:00	21°C	22:00	16.5°C

Heating	1-Morning		2-Work		3-Lunch		4-Afternoon		5-Came back		6-Night	
												
Saturday	6:00	21°C	8:00	16.5°C	12:00	21°C	14:00	16.5°C	18:00	21°C	22:00	16.5°C
Sunday	6:00	21°C	8:00	16.5°C	12:00	21°C	14:00	16.5°C	18:00	21°C	22:00	16.5°C



## Advanced thermostat settings



To access advanced thermostat settings, turn off the device by briefly pressing the **M** key. The device must be off or in standby. Then long press the **P** button (3 seconds) and enter the advanced setting. You can change the values using **▼** or **▲** keys. Press the **P** button to move through the menu and save the settings with the **R** key (exit the settings).

### Settings explanation:

Step	Setting name (default value)	Change option	Description
1	CL (0)	-4 do +4	Temperature display correction
2	AH (350)	20 – 35 (v °C) 68 – 95 (v °F)	Maximum output, operating temperature
3	AL (50)	5 – 20 (v °C) 41 – 68 (v °F)	Lowest output, operating temperature
4	FC (C)	C / F	Temperature display in Celsius or Fahrenheit
5	bL (05)	00 / 05 / 15	Backlight duration in seconds

Step	Setting name (default value)	Change option	Description
6	db (05)	0.5 – 3.0	Temperature range: temperature difference between switching on and off. If, for example, the temperature on the system is set at 22 ° C and the range at 0.5 ° C the heating system starts to operate if the room temperature drops to 21.5 ° C and switches off when the temperature reaches 22.5 ° C.
7	P51 (7)	0 / 2 / 3 / 7	Programming option (see the tables below) 7: Separate setting for each day (Table 1 and 2) 3: 5 days + 1 + 1 (tables 3 and 4) 2: 5 days + 2 weekends (tables 5 and 6) 0: programs disabled
8	P52 (6)	4 / 6	Number of time programs: In one day we can have 4 or 6 different hour and temperature regimes. (see the tables below)
9	OC(24)	12 / 24	24 hours or 12 hours clock display
10	ES (OFF)	On / Off	Smart Adaption, Adjustment - If you have this feature turned on, the thermostat will start heating and functioning before the next heating program is switched on and will try to get to the desired temperature as comfortable as possible. If this function is turned on, the device is constantly learning and adjusting, and calculates how much sooner it has to start with the heating.
11	LA (EN)	En / Ch	Language selection - En (English) or Ch (Chinese)

## **Additional modes**

### **Temporary temperature change (Temporary hold)**

The device has the option of temporarily changing the temperature with the option "temporary hold".

This option is simply activated by manually changing the temperature using ▼ or ▲ buttons. If the option is activated, "TEMPORARY HOLD" appears on the screen (see display description, No. 11). The desired temperature remains active until the change of program schedule occurs. With the **R** button, you can also cancel the activated option.

### **Constant temperature change (Permanent hold)**

The device has the option of constant temperature change with the option "permanent hold". The option allows you to keep a constant temperature every day and hour of the week, independent of the program settings as it overrides them.

This option is simply activated with a longer press (5 seconds) on the **P** key. If the option is activated, "PERMANENT HOLD" appears on the screen (see display description, No. 11). Set the desired temperature using ▼ or ▲ buttons. The "permanent hold" option remains active until it is cancelled by briefly pressing the **P** or **R** key.

### **Key Lock**

This feature allows you to lock the thermostat, and when the function is turned on, any changes to the settings are disabled. Activate the function by holding down ▼ and ▲ buttons at the same time for three seconds. When the function is activated, the lock symbol is displayed (see display description - 14). You can switch off the function by again holding ▼ and ▲ keys for 3 seconds. The lock symbol disappears on the screen.